

# Application of the FPAA to Sample Input Signal for Laboratory Exercise: Pulse Amplitude Modulation

Damian Grzechca, and Lukas Chruszczyk

**Abstract**—This paper presents exemplary exercise on the fundamentals of signal processing course which is offered for second year bachelor level students. Application of Field Programmable Analog Array (FPAA) for pulse amplitude modulation (PAM) exercise is described with signal processing laboratory. There are presented two methods for implementing PAM modulation and demodulation technique in FPAA module. Example configuration files are available form Authors’ web site.

**Keywords**—field programmable analog array (FPAA), signal processing, pulse amplitude modulation (PAM), student laboratory

## I. INTRODUCTION

RAPID electronic circuit prototyping has become very important in the XXI century. Digital circuit design can be implemented on a several platforms e.g. FPGA. The analog design (prototype) is usually limited to electronic circuit simulator. However, there already exist analog reconfigurable circuits which allows for reconfiguration and fast implementation of the analog part. From one hand, a student is familiarized with basic electronic circuits and systems but from the other hand a tutor must create a large set of different laboratory devices in order to fulfill these requirements. There are widely used software based laboratories for fundamentals of signal processing, however an electrical and electronic faculty student must have a good background with real signal comprehension. The introduction for signal processing laboratory contains a set of laboratory exercises like: Fourier Series Expansion, signal approximation passing linear circuit and Pulse Amplitude Modulation (PAM), which apparently shows other theorems like sampling theorem and reconstruction of signal based on the impulses. The signal processing course is offered on the second year bachelor level (engineering level) [1].

## II. FUNDAMENTALS OF SWITCHED CAPACITANCE INTRODUCTION

Field Programmable Analog Array (FPAA) consists of four basic Configurable Analog Blocks (CAB) blocks where various analog functions can be implemented. The analog part operates in the SC (switched capacitance) technology. The internal structure of the FPAA model AN221E04 is shown in the fig. 1. The analog matrix consists of 4 independent modules, the look-up table, input and output interfaces, where the analog functions can be created [2-4].

This work was supported by the Polish Ministry of Science and Higher Education funding for statutory activities.

The fundamentals of the SC technique concept is based on controlling electrical charge flowing through capacitor. Two clocks of frequency  $f_{sw}$  have opposite phases and control two switches  $\Phi 1$  and  $\Phi 2$  (fig. 2). If the switch  $\Phi 1$  is closed (and  $\Phi 2$  is opened) the capacitor is charged according to well-known formula  $q = CU$ , otherwise ( $\Phi 2$  closed,  $\Phi 1$  opened) the capacitor is discharged. During every single cycle a constant electric charge (a quantum charge) flows through the capacitor to the ground. If both switches operate with frequency  $f_{sw}$ , the average current can be expressed by the following formula:

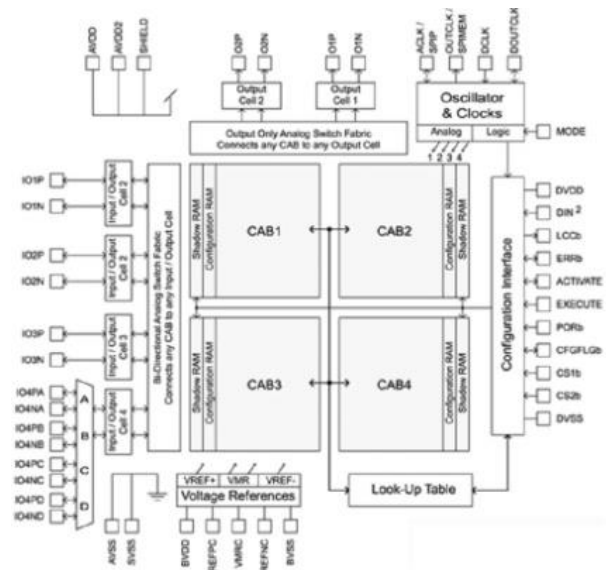

Fig. 1. Structure of the FPAA

$$qf_s = \frac{q}{T_s} = i \quad (1)$$

Hence, the resistance value is the reciprocal of frequency and capacitance:

$$R = \frac{U}{i} = \frac{1}{f_s C} \quad (2)$$

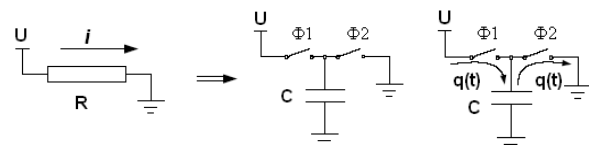

Fig. 2. Resistor in the SC technique

Authors are with the Department of Electrical Engineering, Electronics and Microelectronics, Silesian University of Technology, Gliwice, Poland (e-mail: {dgrzechca}, {lch}@polsl.pl).



During the laboratory each student section uses a function generator for analog input signal creation and FPAA board for sampling input signal and creating reconstructing low pass filter. The last utilized device is digital oscilloscope where all signals are observed and analyzed by students.

### III. PULSE AMPLITUDE MODULATION

PAM is a type of modulation where the information is coded by amplitude of series impulses distributed evenly. The understanding of PAM is essential and makes a good background for complex telecommunication systems [5-7]. Such modulation is applied in Fast Ethernet 100Base-T2, 1000Base-T. This relatively simple exercise should give reasonable knowledge about basic PAM concept. The basic idea of the PAM is shown in the fig. 4. Let us assume input signal as a train of weighted impulses (3):

$$x_s(t) = \sum_{k=-\infty}^{\infty} a_k \delta(t - kT) \quad (3)$$

If the signal passes a filter (e.g. channel filter) it will have the form of (4):

$$x(t) = \sum_{k=-\infty}^{\infty} a_k h_T(t - kT) \quad (4)$$

However, the sampling with Dirac impulses has no practical utilization, thus the practical input pulse has to be applied (Dirac impulse has infinite spectrum). An example of the PAM is presented in fig. 3 and sine wave samples are shown in fig. 4.

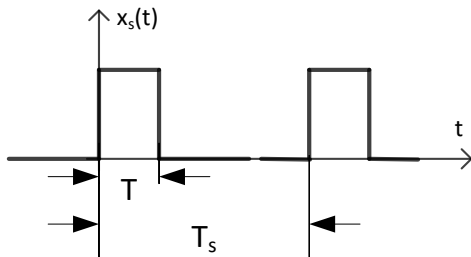

Fig. 3. Pulse train signal, with duty factor  $T/T_s$ , and period  $T_s$ .

Sampling period  $T_s$  must be chosen according to the Nyquist theorem as at least twice of maximum frequency in the sampled signal. The length of the sample is inversely proportional to the channel bandwidth. The time  $T$  has to be chosen with relation to the channel, however it is not a scope of this paper.

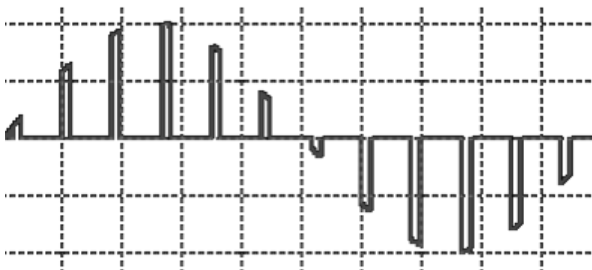

Fig. 4. Sinusoidal waveform ( $f_0$ ) sampled with frequency  $12f_0$ .

Reconstruction of the sampled signal is performed by means of a low-pass filter (fig. 5).

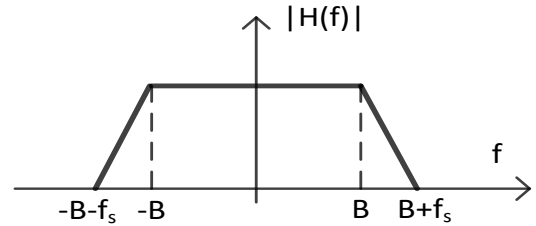

Fig. 5. Amplitude characteristics for regenerating low-pass filter.

Obviously, the spectrum of a single pulse from the fig. 3 is defined by formula (5).

$$H(\omega) = \frac{\sin(\omega T)}{\omega} e^{-0.5j\omega T} \quad (5)$$

Finally, from the (5) flows the conclusion that sampling with impulses instead of Dirac functions causes amplitude distortion and phase delay equals  $0.5T$ . This is one of the reason the PAM has weak noise resistance and it is utilized in TDM (Time division multiplexing) systems.

PAM system can be easily simulated in high level software like Matlab/LabVIEW without even a touch of hardware. However students are waiting for playing with real devices. This is one of the reasons which enforced us to create such exercise using hardware generator, oscilloscope and black box (FPAA).

### IV. FPAA IMPLEMENTATION OF THE SAMPLING CIRCUIT

FPAA offers a wide range of different approaches for sampling of input signal, however proper selection of the pulse train period and width are not trivial. There are some papers on PWM [4] but we could not find the FPAA block diagram for our purpose (PAM). This is the main reason for designing our structure, which additionally can be downloaded from [8, 9]. The general idea is to have a sample and hold circuit with adjustable duty factor (DF) and frequency ( $f_s$ ). For laboratory exercise: DF should be within 10% and 50% and frequency should allow for maximum 25 samples per period (which gives  $25f_0$ ). Let us underline again, the most important is to have a real function generator at the input and an oscilloscope at the output. Both devices are stand-alone equipment in the laboratory and students familiarize with them (fig. 6).



Fig. 6. Devices in the laboratory (function generator Rigol DG4102 and oscilloscope Tektronix DPO3012) together with FPAA circuit.

In order to generate impulses with adjustable duty factor and time period we have built circuits presented in the fig. 7 and 8. The first one is based on the rectangular function generator (bottom waveform), comparator with sample and hold circuit (2<sup>nd</sup> waveform) and a differentiator. This solution allows for frequency change but it does not allow for duty factor variability. Main blocks of the second circuit are arbitrary periodic waveform generator, multiplier and sample&hold block. The circuit works very well but the interval between the following pulses is very limited and inconvenient – the user must change look-up-table (LUT) of the generator, but the period depends on clock and integer number of cells in LUT. First proposition is very good for very narrow pulses generation. The differentiation constant relates to the output amplitude that is energy of an impulse.

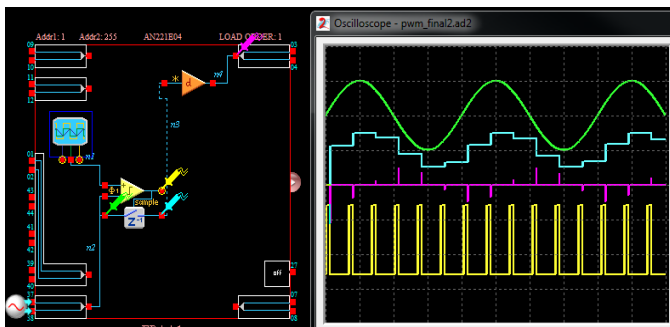

Fig. 7. Sampling a sine wave signal – proposition 1 (file: Sample\_1.ad2). Left: FPAA configuration; right: simulation.

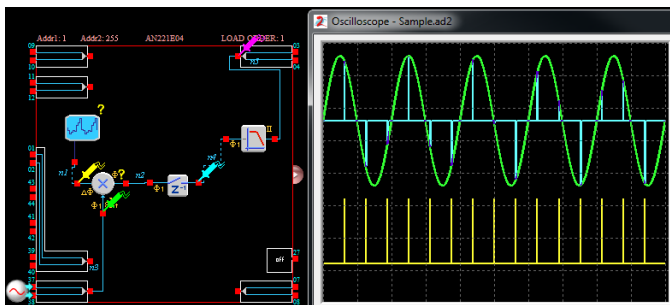

Fig. 8. Sampling a sine wave signal – proposition 2 (file: Sample\_2.ad2). Left: FPAA configuration; right: simulation.

Similar problem occurs for third circuit (fig. 9), but now all parameters are widely adjustable. The frequency of the pulse train depends on sine wave oscillator which can be change with different dynamic reconfiguration options including state driven method which apparently is the most popular. Duty factor can be changed with LUT very precise (precision is 1/255 less than 0.5% that is even too much for laboratory purpose).

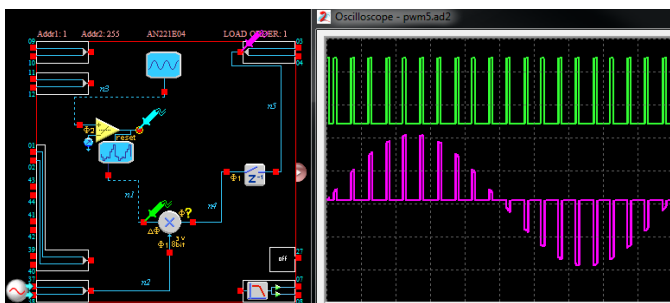

Fig. 9. Sampling a sine wave signal – proposition 3 (file: Sample\_3.ad2). Left: FPAA configuration; right: simulation.

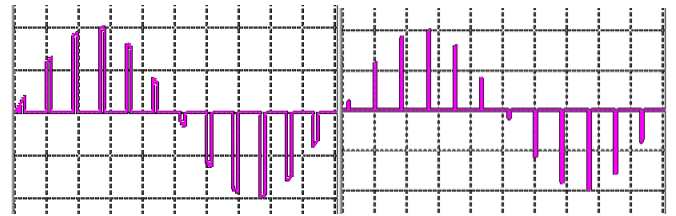

Fig. 10. Simulation for the second configuration. Input: sine wave (differential), ampl=1, freq=5kHz, common mode offset = 2. Scope stings: 20us/div., 0.5V/div. Look-up-table: upper case:  $U_i=1$  for  $i=0, \dots, 5$ ; lower case:  $U_i=1$  for  $i=0, \dots, 1$ .

The last circuit presented in the fig. 10 uses rectangular generator, multiplier and sample&hold circuit. This approach is utilized on the laboratory however it has some disadvantages like limited duty factor settings (between 10% and 90%). If this is not a problem, such approach in the FPAA offers some space for other blocks like biquadratic filter and bilinear filter. Both can perform for reconstruction filter and a student can see what happen if the rectangular signal is sampled and the output filter allows for one harmonic to pass.

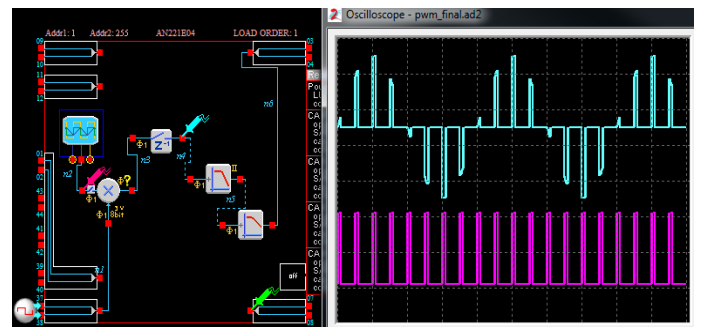

Fig. 11. Sampling a sine wave signal – proposition 4 (file: Sample\_4.ad2). Left: FPAA configuration; right: simulation.

V. VERIFICATION AND EXPERIMENTAL RESULTS

Laboratory exercise has been assembled with devices shown in fig. 6. All FPAA configurations have been applied and verified. Results are gathered in tab. I and in the fig. 12-17. In fig. 12 the first FPAA configuration has been utilized, one can observed very narrow impulses and a phase shift of 90 degrees. The samples do not follow input sine wave signal and this configuration should be discontinued. Next figures represent input signals (sine, rectangular and triangular) sampled with configurations 2, 3 and 4.

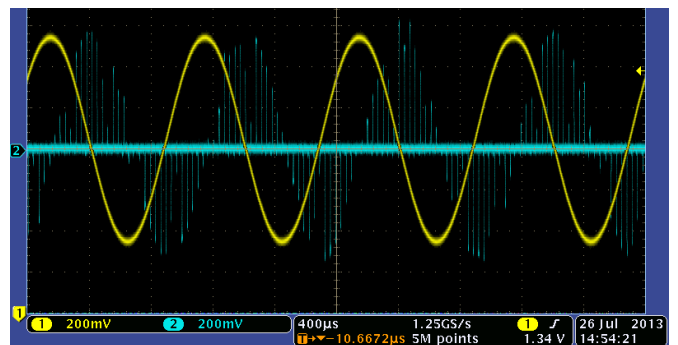

Fig. 12. Sampling a sine wave signal – example with 32 samples per period (narrow sampling pulses).

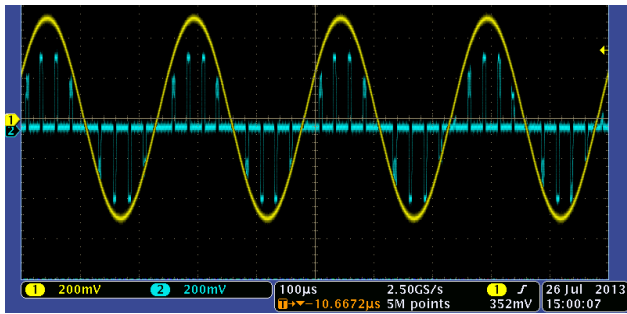

Fig. 13. Sampling a sine wave signal – example with 10 samples per period.

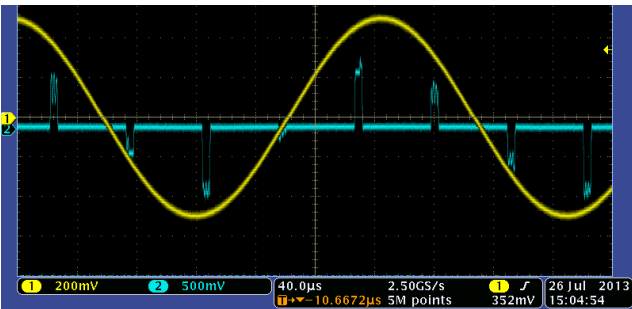

Fig. 14. Sampling a sine wave signal – example with 5 samples per period.

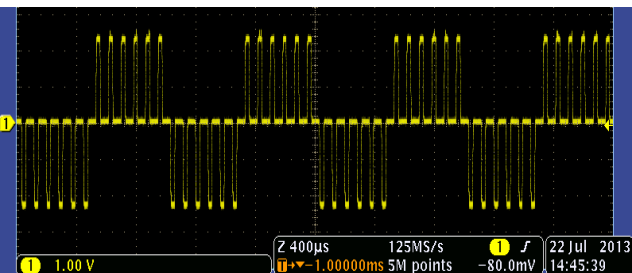

Fig. 15. Sampled rectangular signal (12 samples per period).

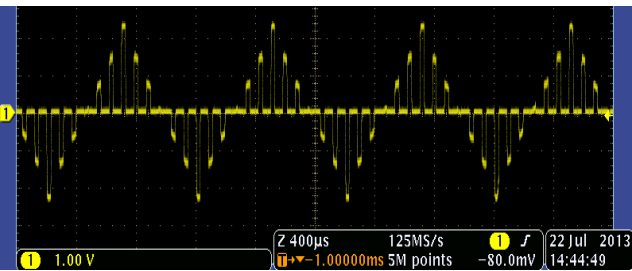

Fig. 16. Sampled triangular signal (12 samples per period).

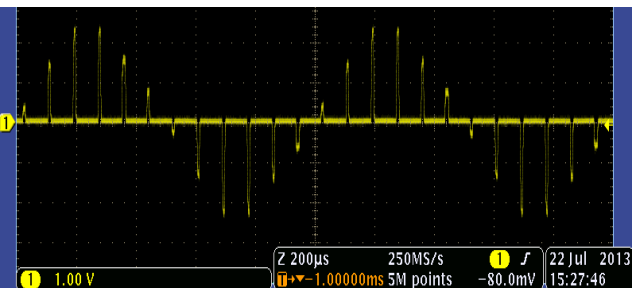

Fig. 17. Sampled triangular signal (12 samples per period, narrow sampling pulses).

The software bundled with FPAA hardware allows static (interactive) and dynamic (during FPAA operation) reconfiguration. Also every ready FPAA configuration can be

used to generate C/C++ code for static or dynamic reconfiguration. Based on this feature, there have been written *dll* files (libraries) in order to control FPAA from external programs. This is base for semi-autonomous laboratory course where students can solve and verify given introductory problems *before* laboratory exercise. The files can be downloaded from Authors' web site [8].

TABLE I  
ADVANTAGES AND DISADVANTAGES OF FPAA CONFIGURATIONS.

FPAA config.	Features		
	<i>Duty factor</i>	<i>Sampling rate</i>	<i>State driven configuration</i>
1.	Not adjustable/constant/very narrow pulse	Depends on main clock (from $2f_0$ up to $25f_0$ )	Frequency possible
2.	LUT (difficult to adjust)	Depends on LUT (difficult to adjust)	Through reset counter (frequency only)
3.	LUT (difficult to adjust)	Possible with DC offset (negative input for comparator)	DC offset level (frequency only)
4.	Adjustable (10%-90%)	Adjustable	Yes, both possible.

## VI. CONCLUSIONS

Four approaches for implementing Pulse Amplitude Modulation in the FPAA hardware have been proposed in this paper. Two accepted FPAA configurations have their advantages and disadvantages. The most important advantage of the second configuration is its on-chip capacity which is smaller (requires fewer resources). It allows for one more biquadratic filter implementation (2<sup>nd</sup> order) which can be used for signal reconstruction. On the other hand the second implementation requires more knowledge if the “black box” is implemented with the 3<sup>rd</sup> part software like LabVIEW, Visual C, etc. This is because only dynamic reconfiguration allows for look-up-table change. The state driven method (generating *ahf* files) does not allow for look-up-table adjustment, so we decided to present both ideas.

Additional advantage is ability for students to remotely (e.g. via Internet) prepare and verify introductory problems before laboratory exercise.

In the near future, there are planned to be connected additional FPAAs in order to create more complex analog circuits.

## REFERENCES

- [1] Berger T., *An Estimation Theory Approach To Pulse Amplitude Modulation Theory*, PN 1965.
- [2] Anadigm, the dpASP Corp., <http://www.anadigm.com>
- [3] Anadigm, Switched Capacitor: Sampled Data System, <http://www.anadigm.com/apps/BasicSC-tech.pdf>
- [4] Piłat A., *Programmable analog hardware for control systems exemplified by magnetic suspension*, Computer Methods and Systems, Cracow, Poland 14-16 November 2005, pp. 143–148.
- [5] Baher H., *Analog & Digital Signal Processing*, J. Wiley & Sons, 1990.
- [6] Allen P.E., Sanchez-Sinencio E., *Switched Capacitor Circuits*, Van Nostrand Reinhold Inc., New York 1984.
- [7] Unbehauen R., Cichocki A., *Mos Switched-Capacitor and Continuous-Time Integrated Circuits and Systems*, Springer-Verlag 1989
- [8] <http://ztois.acei.polsl.pl/index.php/pracownicy/12-dr-hab-inz-damian-grzechca>
- [9] <http://ztois.acei.polsl.pl/index.php/pracownicy/14-dr-inz-lukasz-chruszczyk>