

A 30 GHz Slotted Bow-Tie Rectangular Patch Antenna Design for 5G Application

Khazini Mohammed, Damou Mehdi, and Souar Zeggai

Abstract—This Article presented the study of a single patch antenna and array patch antenna. We will focus on the design based on a small size at a resonant frequency of 30GHz. using the software CST Microwave Studio (FEM method) and ADS software (Moments method) to find internal parameters (S... parameters, bandwidth ,VSWR) and external characteristics (gain, directivity and radiation pattern, efficiencies) .

To increase the total gain of the antenna and to have a wider bandwidth band width and taking advantage of the functionality of the radiation overlap of several elements radiating in the same direction, we suggest the second and most important step to design a most important step to design an antenna array grouping patches identical to our first patch antenna proposed in first patch antenna proposed in the first step

Keywords—slotted bow-tie patch antenna; quarter wave transformer; array antenna, CST studio; ADS 2016

I. INTRODUCTION

THE purpose of this paper is to study the potential of these other structures to promote the integration of antennas and optimize their performance at 30 GHz for 5G. The properties (dielectric, static conductivity) of the substrate composites were carried out by [1] and[2]. Simulated antennas on substrates of characterized materials, to reduce the dimensions of the antennas and optimize their performance (gain, bandwidth, reflection coefficient, radiation patterns,...) in printed circuit type operating contexts.

A quarter-wave impedance transformer is used to change the impedance of the load to another value for impedance where the load impedance is real. a transmission line of a quarter wavelength is designed two parameters, the particular frequency and the length of the transformer is equal to $\lambda_0/4$ only at this designed frequency :

- Impedance matching between a resistive load and transmission lines.
- Impedance matching between two resistive loads.
- Impedance matching between two transmission lines of unequal characteristic impedances.

The design phase of an antenna using suitable software is an essential step for the sake of saving time and optimizing the structure at the desired parameters taking into account the dielectric and conductive parameters chosen from low-cost materials. For this, CST-ADS is used as effective electromagnetic simulation tool to develop complex structures by calculating S-parameters and resonance frequencies as well

as visualizing radiation patterns and electromagnetic fields in order to develop a high performance of the slotted bowtie rectangular patch antenna array serving satellite and radar applications around 30 GHz.

II. QUARTER WAVE TRANSFORMER

The matching devices we have just considered are valid only at the frequency for which the line length is equal to $\lambda/4$: they are therefore narrowband matching devices. To achieve wideband matching, we can split the matching into a number of $\lambda/4$ sections Fig.1 such that the successive input impedances of these different sections are : $Z_0 > Z_2 > Z_1 > Z_L$ and for n sections: $Z_0 > Z_n > Z_{n-1} > \dots > Z_1 > Z_L$

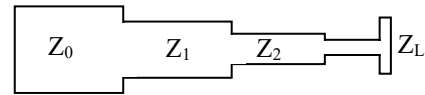

Fig. 1. Quarter wave transformer

A quarter-wave transformer can be used to match a real impedance Z_L to Z_0

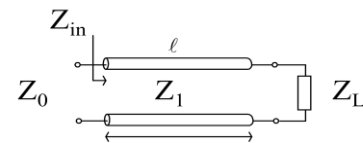

Fig. 2. Wideband adaptation

$$Z_{in} = Z_1 \frac{Z_L + jZ_1 t}{Z_1 + jZ_L t}$$

$$t = \tan \beta l = \tan \theta$$

$$l = \frac{\lambda_0}{4}, \quad Z_{in} = \frac{Z_1^2}{Z_L}$$

the matching condition at f_0 is $Z_1 = \sqrt{Z_0 Z_L}$

At a different frequency $Z_{in} \neq Z_0$ and the input reflection coefficient is

$$\Gamma_{in}|_{Z_0} = \frac{Z_{in} - Z_0}{Z_{in} + Z_0} = \frac{Z_L - Z_0}{Z_L + Z_0 + j2t\sqrt{Z_L Z_0}}$$

This work was supported by the Laboratory Technologies of Communications.

Khazini Mohammed and Damou Mehdi are with the Laboratory of Electronics, Signal Processing and Microwave, Faculty of Technology,

University of Dr. TaharMoulay of Saida, Algeria (e-mail: maamora.kha1980@gmail.com, bouazzamehdi@yahoo.fr).

Souar Zeggai is with the Faculty of Technology, University of Dr. TaharMoulay of Saida, Algeria (e-mail: prof.souar@yahoo.fr).



The mismatch can be computed from:

$$|\Gamma_{in}| = \frac{1}{\sqrt{1 + \frac{4Z_L Z_0}{(Z_L - Z_0)^2 \cos^2 \theta}}}$$

A. Radiation Resistance Calculation Method

The feed in of patch antenna at distance X_f from one of the radiating edges, the input impedance given by following relation [3][4] (26):

$$R_{in} = R_r \cos^2 \left(\frac{\pi X_f}{L} \right)$$

Radiation resistance R_r decreases with the increase in substrate thickness and patch width because of the increase in radiated power.

B. Feed Network Design

The design of patch antenna arrays, there are two kinds of feed networks, the series feed network and the corporate feed network.

C. Directivity And Gain

The function of the patch antenna radiation pattern, la directivity D which is defined by the expression (4). For an isotropic source, the radiation intensity U_0 is equal to the total radiated power P_{rad} divided by 4π . So the directivity can be calculated by:

$$D = \frac{U}{U_0} = \frac{4\pi U}{P_{rad}} \quad (4)$$

If not specified, antenna directivity implies its maximum value, i.e. D_0 .

$$D_0 = \frac{U|_{max}}{U_0} = \frac{U_{max}}{U_0} = \frac{4\pi U_{max}}{P_{rad}} \quad (5)$$

D. Radiation Field

The fields radiated by the current element, it is required to determine magnetic vector potential \vec{A} first.

For Hertzian Dipole, \vec{A} is expressed as:

$$\vec{A} = \frac{\mu_0 I_0 dl}{4\pi r} e^{-jkr} \vec{z} \quad (6)$$

In the spherical coordinate, Equation (6) is transformed to:

$$\begin{aligned} A_r &= A_z \cos \theta = \frac{\mu_0 I_0 dl}{4\pi r} e^{-jkr} \cos \theta \\ A_\theta &= -A_z \sin \theta = -\frac{\mu_0 I_0 dl}{4\pi r} e^{-jkr} \sin \theta \\ A_\phi &= 0 \end{aligned} \quad (7)$$

According to Maxwell's equations and the relationship between \vec{A} and \vec{H} :

$$\nabla \times \vec{E} = -j\omega\mu\vec{H}$$

$$\vec{H} = \frac{1}{\mu} \nabla \times \vec{A} \quad (8)$$

Now E- and H field can be found:

$$\begin{aligned} H_r &= H_\theta = 0 \\ H_\phi &= j \frac{k I_0 dl \sin \theta}{4\pi r} \left[1 + \frac{1}{jkr} \right] e^{-jkr} \\ E_r &= \eta \frac{I_0 dl \cos \theta}{2\pi r^2} \left[1 + \frac{1}{jkr} \right] e^{-jkr} \\ E_\theta &= j\eta \frac{k I_0 dl \sin \theta}{4\pi r} \left[1 + \frac{1}{jkr} - \frac{1}{(kr)^2} \right] e^{-jkr} \\ E_\phi &= 0 \end{aligned} \quad (9)$$

In the far-field region where $kr \gg 1$, the E and H-field can be simplified and approximated by:

$$\begin{aligned} E_\theta &\approx j\eta \frac{k I_0 dl \sin \theta}{4\pi r} e^{-jkr} \\ E_r &\approx E_\phi = H_r = H_\theta = 0 \\ H_\phi &\approx j \frac{k I_0 dl \sin \theta}{4\pi r} e^{-jkr} \end{aligned} \quad (10)$$

The ratio of E_θ and H_ϕ is:

$$Z_\omega = \frac{E_\theta}{H_\phi} \approx \eta \quad (11)$$

where Z_ω is the wave impedance; η is the intrinsic impedance of the medium ($377 \approx 120\pi$ Ohms for free space). The width W and L for a patch of rectangular shape given by the formulas follows

$$w = \frac{c}{2f_0 \sqrt{\frac{\epsilon_r + 1}{2}}} \quad (12)$$

From the modeling point of view, the two media are replaced by an effective medium characterized by a dielectric constant expressed by:

$$\epsilon_{reff} = \frac{(\epsilon_r + 1)}{2} + \frac{(\epsilon_r - 1)}{2} \left(1 + 10 \frac{h}{w} \right)^{-\frac{1}{2}} \quad (13)$$

The patch is electrically extended by a value ΔL on each side such that:

$$\Delta L = 0.412h \frac{(\epsilon_{eff} + 0.3) \left(\frac{w}{h} + 0.264 \right)}{(\epsilon_{eff} - 0.258) \left(\frac{w}{h} + 0.8 \right)} \quad (14)$$

alors $L = L_{eff} - 2\Delta L$ avec L_{eff} est donnée par:

$$L_{eff} = \frac{c}{2f_0 \sqrt{\epsilon_{reff}}} \quad (15)$$

III. ANTENNA GEOMETRY

The structure of the slotted bowtie rectangular patch antenna is shown in Fig.3 at a center frequency of 30GHz. The first step in designing an antenna consists of choosing the right substrate. A suitable substrate depends on its availability; to achieve such goals, a high performance dielectric substrate ("Arlon CuClad 233 (tm)") with thickness ($h = 0.49\text{mm}$), Relative permittivity ($\epsilon_r = 2.43$) and tangent loss ($\tan \delta = 0.0013$) is chosen as substrate [8].

The dimensions of the proposed antenna are shown in Table I.

Parameters	L_p	w_p	L_f	w_f	w_2	w_3	R
Values (mm)	3.2	4.35	1.82	1.44	0.755	0.49	0.9

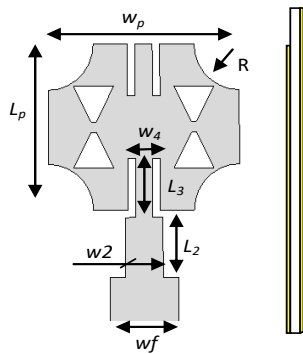

Fig. 3. Geometry of the proposed impedance matching techniques by Quarter wave transformer Antenna

The dimensions of this antenna determine the center frequency [5][6], and for a regular rectangular patch the edge impedance is 267Ω .

IV. RESULT AND DISCUSSIONS

The proposed single element antenna is designed modified with inset line, the simulation result of antenna rectangular bow-tie slot using CST software FEM method solver technique and ADS software method of Moments based by Green's function.

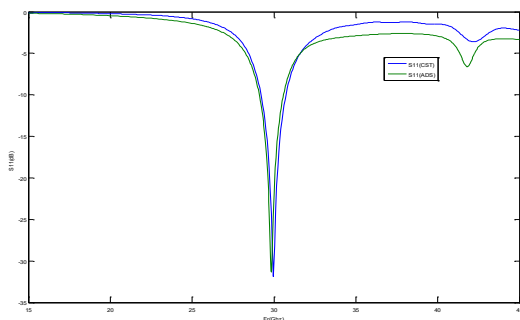

Fig.4. Return loss (dB) of simulated single element antenna

The simulation result of the slotted bowtie rectangular patch antenna shows the reflection coefficient S11 as a function of frequency Fig.4 . It can be observed that this antenna resonated at 30 GHz and at 42 GHz with parameter values (return losses)

of -31 dB and -7dB respectively. The operation of the antenna for the range frequency of - 30.76dB 29.54 GHz or bandwidth of 4.76%.

Fig.5 shows the simulation result gives a field E and H at frequency 30Ghz

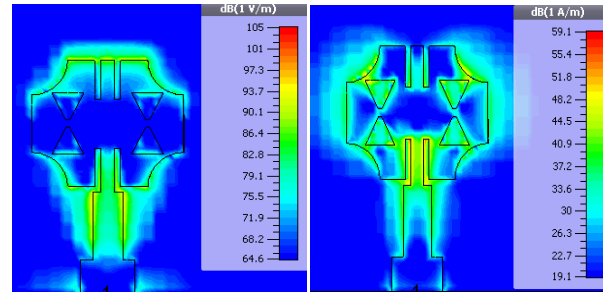

Fig 5. Radiation pattern at 30 GHz (a) E field, (b)H field

The simulation result at the frequency of 30 GHz, the maximum gain of the single element patch antenna is 8.08 dB is shown in Fig.6. This indicates that the antenna is able to direct the input power towards the radiation in a given direction more than in other directions. The single element patch antenna is capable of emitting or receiving a signal efficiently in the direction of the highest gain.

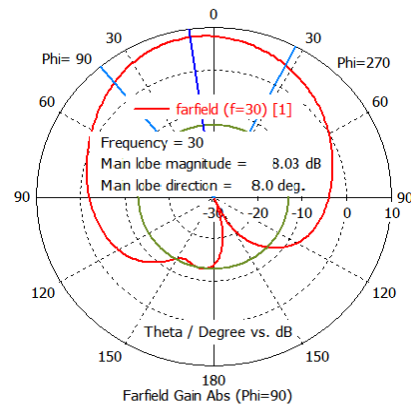

Fig. 6. Gain simulation (2D) result of the single element

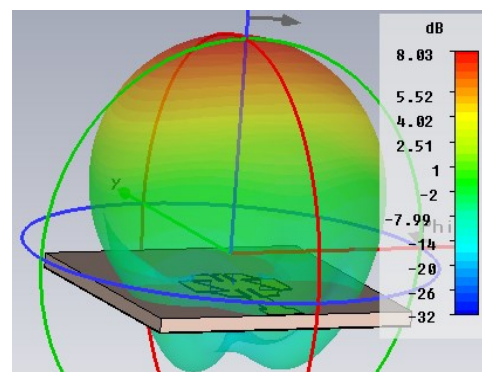

Fig. 7. Simulation 3D result of the single element antenna

Fig.7 represent a radiation pattern characterizes the variation of the radiated far-field intensity Gain (3D) of an antenna as an angular function at a specific frequency

V.ARRAY ANTENNA CONFIGURATION TWO ELENENTS

The array consists of two symmetrical patch elements that are fed in parallel to design the antenna array (figure 8) where each element has the same dimensions as mentioned above in order to increase the performance of the antenna. The length of the power divider is 0.95 mm and its width is 1.2 mm. The distance between the centers of the two feed lines is 4.7 mm [12].

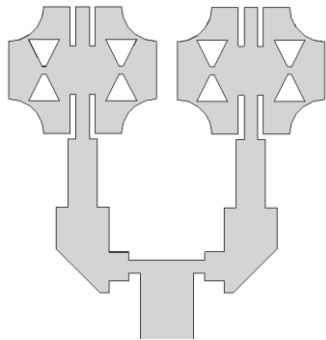

Fig. 8. Geometry of the proposed impedance matching technique by Quarter wave transformer Antenna

The dimensions of the design have been optimized to increase its impedance bandwidth. The results obtained with both simulation methods for the final design are compared in Fig. 9.

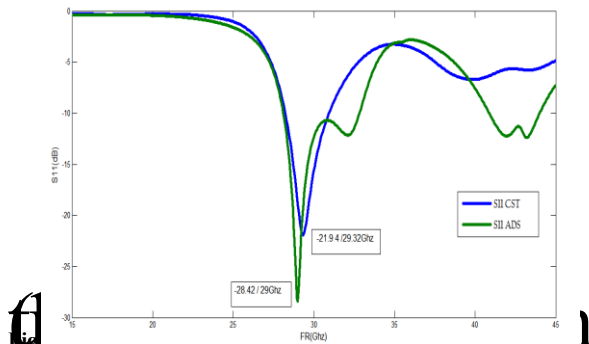

Fig 9. Simulation of the antenna design using ADS (Method of Moments) and CST (Finite Element Method)

The proposed design has been studied using the Agilent Advanced Design System Method of Moments (Momentum)electromagnetic simulator the results of this method $S_{11}=-28.42$ at $f_r=29$ GHz and the values result CST Studio FEM method is $S_{11}=-21.94$ at $f_r=29.32$.

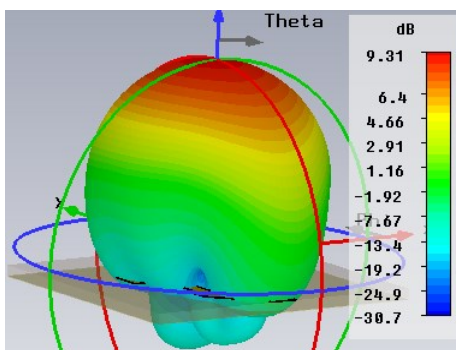

Fig. 10. Gain simulation 3D result of the array antenna Two elements

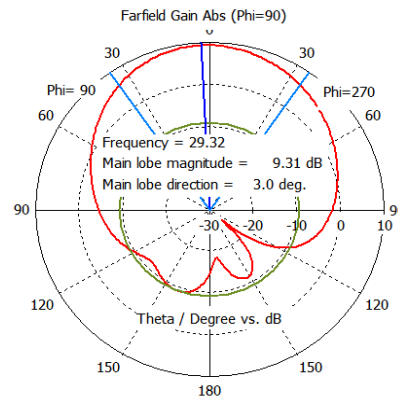

Fig. 11. Gain simulation (2D) result of the Two elements

Fig.10 and Fig11 are represents radiated far-field intensity Gain (3D)(2D) result of the Two elements patch antenna. The value far-field Gain of array antenna at 29.32 GHz is 9.31dB

V. ARRAY ANTENNA CONFIGURATION FOUR ELEMENTS

Here four elements (figure 12) are used and each element has the same dimensions as mentioned above in order to increase the performance of the antenna array. The length of the power divider is 0.95mm and its width is 1.2 mm with a total dimension of 18.5x5.25mm².

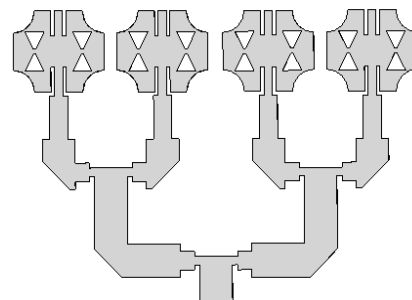

Fig 12. Proposed array antenna four elements configuration

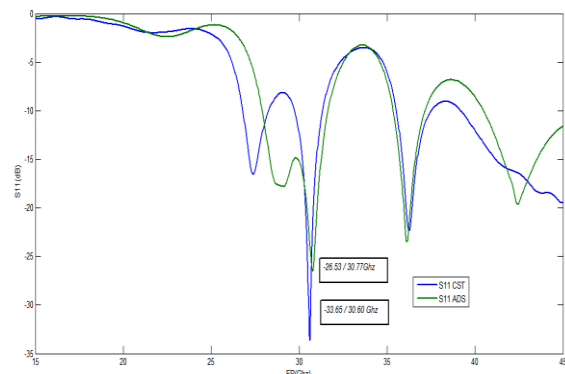

Fig. 13. Return loss (dB) of the simulated array antenna-Two elements

The figure Fig13 shows that the return loss of the array antenna two elements with CST Studio is -33.65 dB at a center frequency of 30.60 GHz and ADS is -26 dB at a center frequency of 30.77 GHz.

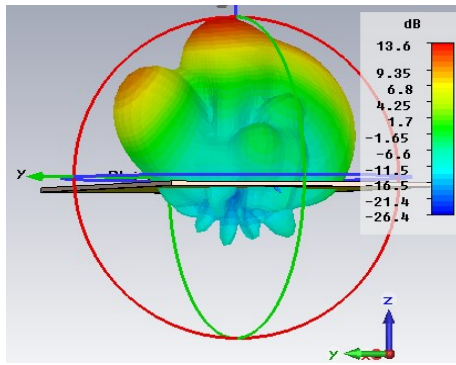

Fig. 14. Gain simulation 3D result of the array antenna four elements

TABLE I
COMPARISON OF PROPOSED ANTENNA SIMULATION VALUES

		01 element	02 elements	04 elements
Moment Method (ADS)	f_r	29.54	29	30.77
	S_{11}	-30.76	-28.42	-26.53
	Gain	7.67	9.31	13.1
FEM Method (CST)	f_r	30	29.32	30.6
	S_{11}	-31	-21.94	-33.65
	Gain	8.03	8.93	13.6

VI. CONCLUSION

The structure proposed slotted bowtie rectangular patch antenna has been computed and optimized by using two electromagnetic solvers ADS and CST-MW. The simulated parameters present an important result, in terms of return loss, gain, field E and H, in the frequency range 27–31.5 GHz with a bandwidth of 15.83%. The maximum gain is 13.6 dB with the bandwidth between 27 to 31 GHz; than that of the traditional microstrip fed bow-tie slot rectangular patch array antenna. Printed slot antennas fed by a microstrip have many advantages; Besides small size, light weight, low cost, good performance.

REFERENCES

- [1] K. Wei, B. Zhu, and M. Tao, "The Circular Polarization Diversity Antennas Achieved by A Fractal Defected Ground Structure," IEEE Access, pp. 1–1, 2019. <https://doi.org/10.1109/ACCESS.2019.2927280>
- [2] A. Bharathi, L. Merugu, and P. V. D. Somasekhar Rao, "Reconfigurable Corner Truncated Square Microstrip Patch Antennas for Wireless Communication Applications," IETE Journal of Research, pp. 1–14, Jun. 2018 <https://doi.org/10.1080/03772063.2018.1478326>
- [3] B. Anantha, L. Merugu, and P. V. Somasekhar Rao, "Polarization Reconfigurable Corner Truncated Square Microstrip Array Antenna," IETE Journal of Research, pp. 1–8, Jan. 2019. <https://doi.org/10.1080/03772063.2018.1557084>
- [4] Kin-Lu Wong, Compact and Broadband Microstrip Antennas, Jon Wiley & Sons, Inc., 2002
- [5] C.A.Balanis, "Antenna Theory," John Wiley & Sons Inc, 1999
- [6] D.M. Pozar and B. Kaufman, "Increasing the Bandwidth of a Microstrip Antenna by Proximity Coupling", Electronic Letters, Vol- 23, pp 12-14, April-1987. <https://doi.org/10.1049/el:19870270>
- [7] Jagdish. M. Rathod "Comparative Study of Microstrip Patch Antenna for Wireless Communication Application," International journal of innovation, Management and Technology, Vol 1, No.2, 2010.
- [8] "Comparison of performance characterization in 2x2,3x3 and 4x4 Array Antennas," IJERA, Vol 1, Issue4, pp.2091-2095 1.001.502.002. 503.003.504.00
- [9] Rahman A., Hossain M., Iqbal I.S., Sobhan S., "Design and Performance Analysis of A Dual-band Microstrip Patch Antenna for Mobile WiMAX, WLAN, Wi-Fi and Bluetooth Applications," 2014 International Conference On Informatics, Electronics & Vision, May 23-24, 2014 <https://doi.org/10.1109/ICIEV.2014.6850867>
- [10] Redzwan F.N.M., Ali M.T., Tan M.N., Miswadi N.F., Design of Tri-band Planar Inverted F Antenna (PIFA) with Parasitic Elements for UMTS2100, LTE and WiMAX Mobile Applications, IEEE 2015 Intern. Conf. on Computer, Comm., and Control Technology, April 21 – 23, 2015, pp. 550-554 <https://doi.org/10.1109/I4CT.2015.7219639>
- [11] Mieczysława M., Computer-aided modeling and analysis of antennas of mobile devices radio communication systems, Master Thesis, Bialystok University of Technology, Faculty of Electrical Engineering, 2016
- [12] Jun S.Y., Eliabiy A., Sanz-Izquierdo B., Winchester L., Bird D. and McClelland A., "3-D Printing of Conformal Antennas for Diversity Wrist Worn Applications," in IEEE Transactions on Components, Packaging and Manufacturing Technology, vol. 8, no. 12, 2227-2235, December 2018. <https://doi.org/10.1109/TCPMT.2018.2874424>
- [13] Moscato S. et al., "Infill-Dependent 3-D-Printed Material Based on NinjaFlex Filament for Antenna Applications," in IEEE Antennas and Wireless Propagation Letters, vol. 15, pp. 1506-1509, 2016. <http://dx.doi.org/10.1109/LAWP.2016.2516101>